

### FEATURES

- Complete Microphone Conditioner in an 8-Lead Package
- Single 5 V Operation
- Preset Noise Gate Threshold
- Compression Ratio Set by External Resistor
- Automatic Limiting Feature Prevents ADC Overload
- Adjustable Release Time
- Low Noise and Distortion
- 20 kHz Bandwidth ( $\pm 1$  dB)
- Low Cost

### APPLICATIONS

- Microphone Preamplifier/Processor
- Computer Sound Cards
- Public Address/Paging Systems
- Communication Headsets
- Telephone Conferencing
- Guitar Sustain Effects Generator
- Computerized Voice Recognition
- Surveillance Systems
- Karaoke and DJ Mixers

### GENERAL DESCRIPTION

The SSM2165 is a complete and flexible solution for conditioning microphone inputs in computer audio systems. It is also excellent for improving vocal clarity in communications and public address systems. A low noise voltage controlled amplifier (VCA) provides a gain that is dynamically adjusted by a control loop to maintain a set compression characteristic. The compression ratio is set by a single resistor and can be varied from 1:1 to over 15:1 relative to the fixed rotation point. Signals above the rotation point are limited to prevent overload and to eliminate "popping." A downward expander (noise gate) prevents amplification of noise or hum. This results in optimized signal levels prior to digitization, thereby eliminating the need for additional gain or attenuation in the digital domain that could add noise or impair accuracy of speech recognition algorithms. The flexibility of setting the compression ratio and the time constant of the level detector, coupled with two values of rotation point, make the SSM2165 easy to integrate in a wide variety of microphone conditioning applications.

The SSM2165 is an ideal companion product for audio codecs used in computer systems, such as the AD1845 and AD1847. The device is available in 8-lead SOIC and P-DIP packages, and guaranteed for operation over the extended industrial temperature range of  $-40^{\circ}\text{C}$  to  $+85^{\circ}\text{C}$ . As shown in Figure 1a, the SSM2165-1 has a rotation point of  $-25.7$  dBu ( $40$  mV)<sup>1</sup>, a VCA gain of 18 dB, and gives  $-7.7$  dBu ( $320$  mV) before limiting. As shown in Figure 1b, the SSM2165-2 has a rotation point of  $-17.8$  dBu ( $100$  mV),

\*Patents pending.

<sup>1</sup>All signals are in rms volts or dBu (0 dBu = 0.775 V rms).

### REV. B

Information furnished by Analog Devices is believed to be accurate and reliable. However, no responsibility is assumed by Analog Devices for its use, nor for any infringements of patents or other rights of third parties that may result from its use. No license is granted by implication or otherwise under any patent or patent rights of Analog Devices.

### FUNCTIONAL BLOCK DIAGRAM

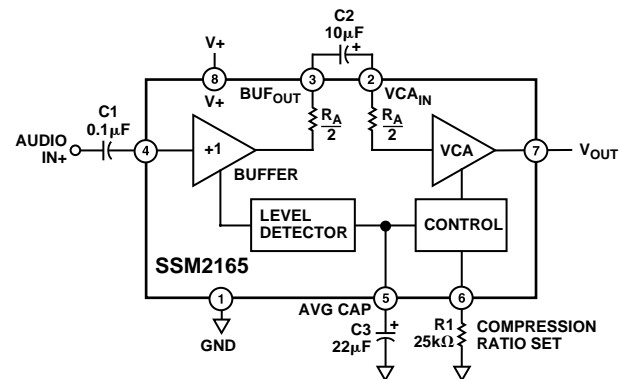

a VCA gain of 8 dB and gives  $-9.8$  dBu ( $250$  mV) before limiting. Both have a noise gate threshold of  $-64$  dBu ( $500$   $\mu\text{V}$ ), below which downward expansion reduces the gain with a ratio of approximately 1:3. That is, a  $-3$  dB reduction of output signal occurs with a  $-1$  dB reduction of input signal. For applications requiring adjustable noise gate threshold, VCA gain up to 18 dB, and adjustable rotation point, please refer to the SSM2166.

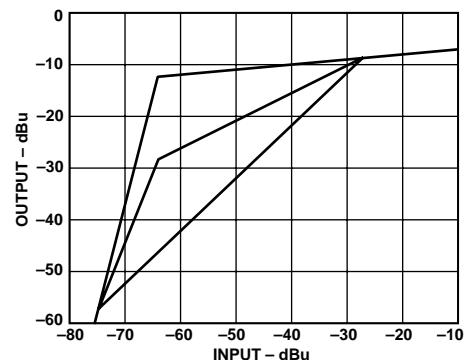

Figure 1a. SSM2165-1 Compression and Gating Characteristics

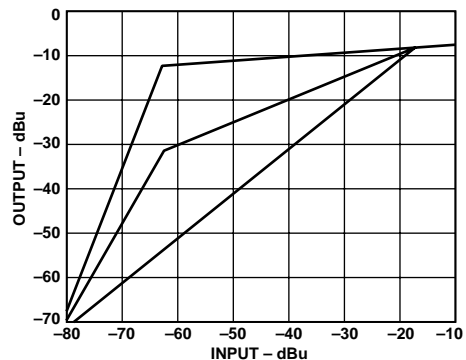

Figure 1b. SSM2165-2 Compression and Gating Characteristics

# SSM2165—SPECIFICATIONS ( $V_+ = 5\text{ V}$ , $f = 1\text{ kHz}$ , $R_L = 100\text{ k}\Omega$ , $R_{\text{COMP}} = 0\text{ }\Omega$ , $T_A = 25^\circ\text{C}$ , unless otherwise noted)

Parameter	Symbol	Conditions	Min	Typ	Max	Unit
<b>AUDIO SIGNAL PATH</b>						
Voltage Noise Density	$e_n$	15:1 Compression, $V_{\text{IN}} = \text{GND}$		17		$\text{nV}/\sqrt{\text{Hz}^2}$
Noise		20 kHz Bandwidth, $V_{\text{IN}} = \text{GND}$		-109		$\text{dBu}^1$
Total Harmonic Distortion	THD+N					
SSM2165-1		2nd and 3rd Harmonics, $V_{\text{IN}} = -30\text{ dBu}$		0.2	0.5	%
SSM2165-2		2nd and 3rd Harmonics, $V_{\text{IN}} = -20\text{ dBu}$		0.2	0.5	%
Input Impedance	$Z_{\text{IN}}$	22 kHz Low-Pass Filter		180		$\text{k}\Omega$
Output Impedance	$Z_{\text{OUT}}$			75		$\Omega$
Load Drive		Resistive	5			$\text{k}\Omega$
		Capacitive			2	$\text{nF}$
Input Voltage Range		1% THD		1		$\text{V rms}$
Output Voltage Range		1% THD		1.4		$\text{V rms}$
Gain Bandwidth Product		1:1 Compression				
SSM2165-1		VCA G = 18 dB		300		$\text{kHz}$
SSM2165-2		VCA G = 8 dB		100		$\text{kHz}$
<b>CONTROL SECTION</b>						
VCA Dynamic Gain Range				40		$\text{dB}$
VCA Fixed Gain						
SSM2165-1				18		$\text{dB}$
SSM2165-2				8		$\text{dB}$
Rotation Point						
SSM2165-1				40		$\text{mV rms}$
SSM2165-2				100		$\text{mV rms}$
Compression Ratio, Min				1:1		
Compression Ratio, Max				15:1		
Control Feedthrough		15:1 Compression		$\pm 5$		$\text{mV}$
<b>POWER SUPPLY</b>						
Supply Voltage Range	$V_S$		4.5		5.5	$\text{V}$
Supply Current	$I_{\text{SY}}$			7.5	10	$\text{mA}$
Quiescent Output Voltage Level				2.2		$\text{V}$
Power Supply Rejection Ratio <sup>2</sup>	PSRR			50		$\text{dB}$

## NOTES

<sup>1</sup>0 dBu = 0.775 V rms.

<sup>2</sup>Referred to input.

Specifications subject to change without notice.

## ABSOLUTE MAXIMUM RATINGS

Supply Voltage . . . . . 10 V  
 Audio Input Voltage . . . . . Supply Voltage  
 Operating Temperature Range . . . . . -40°C to +85°C  
 Storage Temperature Range . . . . . -65°C to +150°C  
 Junction Temperature (T<sub>J</sub>) . . . . . 150°C  
 Lead Temperature (Soldering, 60 sec) . . . . . 300°C

## ESD RATINGS

883 (Human Body) Model . . . . . 2.0 kV

## THERMAL CHARACTERISTICS

Thermal Resistance

8-Lead Plastic DIP

$\theta_{JA}$  . . . . . 103°C/W  
 $\theta_{JC}$  . . . . . 43°C/W

8-Lead SOIC

$\theta_{JA}$  . . . . . 158°C/W  
 $\theta_{JC}$  . . . . . 43°C/W

## ORDERING GUIDE

Model	Temperature Range	Package Description	Package Options
SSM2165-1P*	-40°C to +85°C	Plastic DIP	N-8
SSM2165-1S	-40°C to +85°C	Narrow SOIC	SO-8
SSM2165-2S	-40°C to +85°C	Narrow SOIC	SO-8

\*Not for new design, obsolete April 2002.

## PIN CONFIGURATION

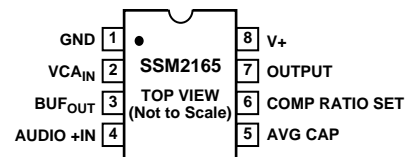

## PIN FUNCTION DESCRIPTIONS

Pin #	Mnemonic	Function
1	GND	Ground
2	VCA <sub>IN</sub>	VCA Input Pin. A typical connection is a 1 μF–10 μF capacitor from the buffer output pin (Pin 3) to this pin.
3	BUF <sub>OUT</sub>	Input Buffer Amplifier Output Pin. Must not be loaded by capacitance to ground.
4	AUDIO +IN	Input Audio Signal. The input signal should be ac-coupled (0.1 μF typical) into this pin.
5	AVG CAP	Detector Averaging Capacitor. A capacitor, 2.2 μF–22 μF, to ground from this pin is the averaging capacitor for the detector circuit.
6	COMP RATIO SET	Compression Ratio Set Pin. A resistor to ground from this pin sets the compression ratio as shown in TPC 1.
7	OUTPUT	Output Signal.
8	V+	Positive Supply, 5 V Nominal.

## CAUTION

ESD (electrostatic discharge) sensitive device. Electrostatic charges as high as 4000 V readily accumulate on the human body and test equipment and can discharge without detection. Although the SSM2165 features proprietary ESD protection circuitry, permanent damage may occur on devices subjected to high-energy electrostatic discharges. Therefore, proper ESD precautions are recommended to avoid performance degradation or loss of functionality.



# SSM2165—Typical Performance Characteristics

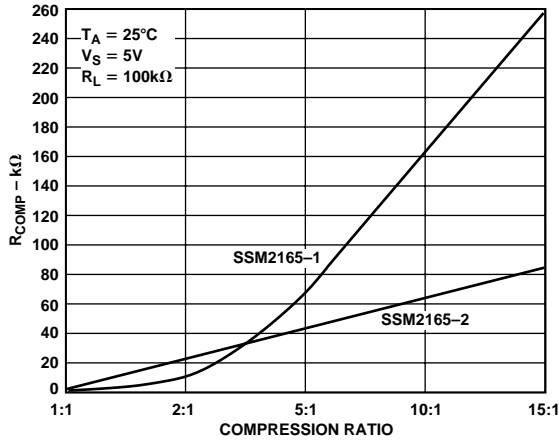

TPC 1. Compression Ratio vs.  $R_{COMP}$

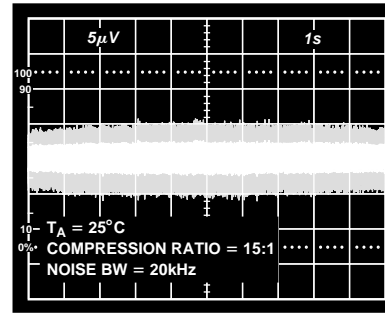

TPC 4. Wideband Output Noise

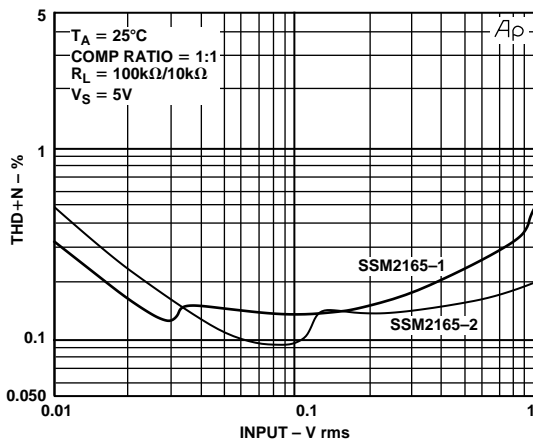

TPC 2. THD + N (%) vs. Input (V rms)

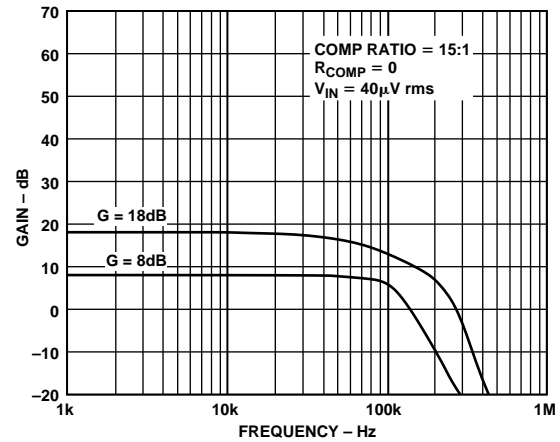

TPC 5. GBW Curves vs. VCA Gain

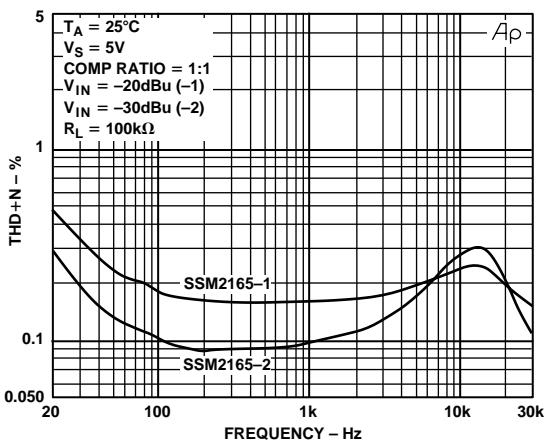

TPC 3. THD + N (%) vs. Frequency (Hz)

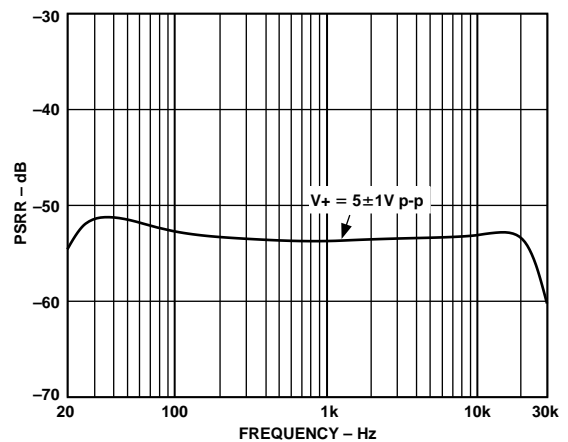

TPC 6. PSRR vs. Frequency, Referred to Input

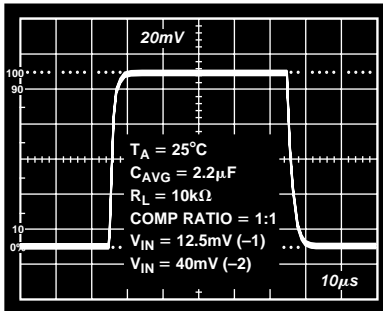

TPC 7. Small Signal Transient Response

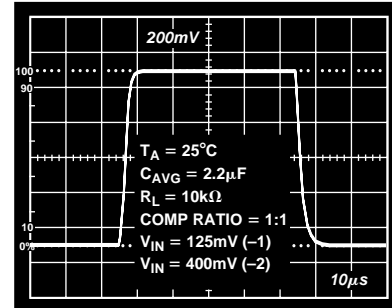

TPC 8. Large Signal Transient Response

## APPLICATIONS INFORMATION

The SSM2165 is a complete microphone signal conditioning system in a single integrated circuit. Designed primarily for voiceband applications, this integrated circuit provides amplification, rms detection, limiting, variable compression, and downward expansion. The internal rms detector has a time constant set by an external capacitor. An integral voltage-controlled amplifier (VCA) provides up to 40 dB of gain in the signal path with approximately 30 kHz bandwidth. The device operates on a single 5 V supply, accepts input signals up to 1 V<sup>1</sup>, and produces output signal levels at limiting of 320 mV and 250 mV for the SSM2165-1 and SSM2165-2 respectively, into loads > 5 kΩ.

The SSM2165 contains an input buffer and automatic gain control (AGC) circuit for audio and voice band signals. Circuit operation is optimized by providing user-adjustable compression ratio and time constant. A downward expansion (noise gating) feature reduces background and circuit noise below 500 µV. The rotation point determines the output signal levels before limiting (referred to the input), and is 40 mV for the SSM2165-1 and 100 mV for the SSM2165-2.

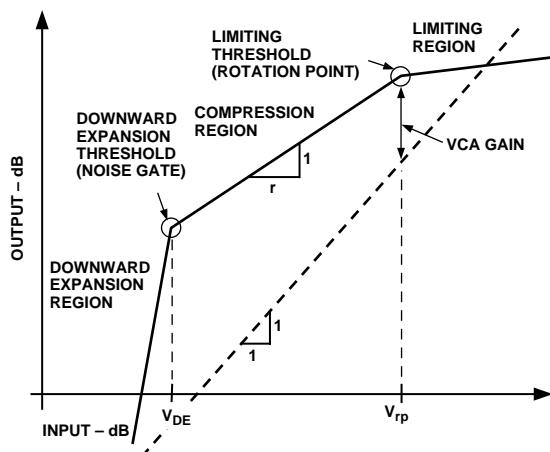

Figure 2. General Input/Output Characteristics of the SSM2165

## THEORY OF OPERATION

Figure 2 illustrates the general transfer characteristic for the SSM2165 where the output level in dBu is plotted as a function of the input level in dBu (0 dBu = 0.775 V rms). For input signals in the range of  $V_{DE}$  (Downward Expansion) to  $V_{RP}$  (Rotation Point) an “r” dB change in the input level causes a 1 dB change in the output level. Here, “r” is defined as the “compression ratio.” The compression ratio may be varied from 1:1 (no compression) to over 15:1 via a single resistor,  $R_{COMP}$ . Input signals above  $V_{RP}$  are compressed with a fixed compression ratio of approximately 10:1. This region of operation is the “limiting region.” Varying the compression ratio has no effect on the limiting region. The breakpoint between the compression region and the limiting region is referred to as the “limiting threshold” or “rotation point,” and is different for the SSM2165-1 and SSM2165-2, see Table I.

Table I. Characteristics vs. Dash Number

SSM2165	Rotation Point	Gain	Output*
-1	40 mV (-25.7 dBu)	18 dB	320 mV (-6 dBu)
-2	100 mV (-17.7 dBu)	8 dB	250 mV (-8 dBu)

\*At limiting.

The term “rotation point” derives from the observation that the straight line in the compression region “rotates” about this point on the input/output characteristic as the compression ratio is changed.

When the compression is set to 2:1, a -2 dB change of the input signal level in the compression region causes -1 dB change of the output level. Likewise, at 10:1 compression, a -10 dB change of the input signal level in the compression region causes a -1 dB change in the output level. The gain of the system with an input signal level of  $V_{RP}$  is fixed regardless of the compression ratio, and is different for the SSM2165-1 and SSM2165-2 (see Figures 1a and 1b). The “nominal gain” of the system is 18 dB for the SSM2165-1, and 8 dB for the SSM2165-2. System gain is measured at  $V_{RP}$  and is  $(V_{OUT} - V_{IN})$  in dB.

Input signals below  $V_{DE}$  are downward expanded at a ratio of approximately 1:3. As a result, the gain of the system is small for very small input signal levels below  $V_{DE}$ , even though it may be quite large for input signals above  $V_{DE}$ . The downward expansion threshold,  $V_{DE}$ , is fixed at 500 µV (-64 dBu) for both dash versions.

<sup>1</sup>All signals are in rms volts or dBu (0 dBu = 0.775 V rms).



### Control Circuitry

The output of the rms level detector is a signal proportional to the log of the true rms value of the buffer output with an added dc offset. The control circuitry subtracts a dc voltage from this signal, scales it, and sends the result to the VCA to control the gain. The VCA's gain control is logarithmic: a linear change in control signal causes a dB change in gain. It is this control law that allows linear processing of the log rms signal to provide the flat compression characteristic on the input/output characteristic shown in Figure 2.

### Compression Ratio

Changing the scaling of the control signal fed to the VCA causes a change in the circuit's compression ratio, "r." This effect is shown in Figure 6. The compression ratio can be set by connecting a resistor between the COMP RATIO pin (Pin 6) and GND. Lowering RCOMP gives smaller compression ratios as indicated in TPC 1, with values of about 5 k $\Omega$  or less resulting in a compression ratio of 1:1. AGC performance is achieved with compression ratios between 2:1 and 15:1, and is dependent on the application. A 200 k $\Omega$  potentiometer may be used to allow this parameter to be adjusted.

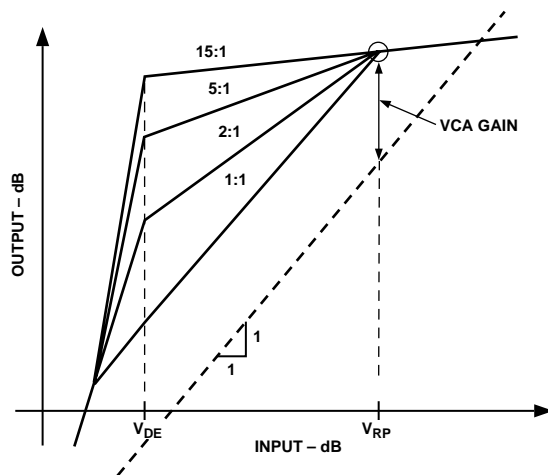

Figure 6. Effect of Varying the Compression Ratio

### Rotation Point

An internal dc reference voltage in the control circuitry sets the rotation point. The rotation point determines the output level above which limiting occurs. That is, in the limiting region, a 10 dB change of input results in a 1 dB change of output. The rotation point is set to 40 mV (-26 dBu) for the SSM2165-1 and 100 mV (-18 dBu) for the SSM2165-2. In the SSM2165, limiting is compression at a fixed compression ratio of approximately 15:1. The fixed gain in the VCA is 18 dB for the SSM2165-1 and 8 dB for the SSM2165-2. The output signals at limiting are, therefore, 320 mV and 250 mV respectively. These are summarized in Table I.

### Maximum Output

Since limiting occurs for signals larger than the rotation point ( $V_{IN} > V_{RP}$ ), the rotation point effectively sets the maximum output signal level. The application will determine which version of the SSM2165 should be selected. The output level should match the maximum input allowed by the following stage. Occasional larger signal transients will then be attenuated by the action of the limiter.

### Downward Expansion Threshold

The downward expansion threshold, or noise gate, is determined by a reference voltage internal to the control circuitry. The noise gate threshold is 500  $\mu$ V for both versions of the SSM2165. Users requiring some other noise gate should consider using the SSM2166. High volume users may wish to consider a custom version of the SSM2165 with other noise gate thresholds or rotation points.

### Power-On/Power-Off Settling Time

Cycling the power supply to the SSM2165 will result in quick settling times: the off-on settling time of the SSM2165 is less than 200 ms, while the on-off settling time is less than 1 ms. Note that transients may appear at the output of the device during power up and power down. A clickless mute function is available on the SSM2166 only.

### PC Board Layout Considerations

Since the SSM2165 is capable of wide bandwidth operation at high gain, special care must be exercised in the layout of the PC board which contains the IC and its associated components. The following applications hints should be considered and/or followed:

1. In some high system gain applications, the shielding of input wires to minimize possible feedback from the output of the SSM2165 back to the input circuit may be necessary.
2. A single-point ("star") ground implementation is recommended in addition to maintaining short lead lengths and PC board runs. In systems where an analog ground and a digital ground are available, the SSM2165 and its surrounding circuitry should be connected to the analog ground. Wire-wrap board connections and grounding implementations are to be explicitly avoided.
3. The internal buffer of the SSM2165 was designed to drive only the input of the internal VCA and its own feedback network. Stray capacitive loading to ground from either Pin 3 or Pin 2 in excess of 5 pF to 10 pF can cause excessive phase shift and can lead to circuit instability.
4. When using high impedance sources, it can be advantageous to shunt the source with a capacitor to ground at the input pin of the IC (Pin 4) to lower the source impedance at high frequencies, as shown in Figure 7. A capacitor with a value of 1000 pF is a good starting value and sets a low pass corner at 31 kHz for 5 k $\Omega$  sources.

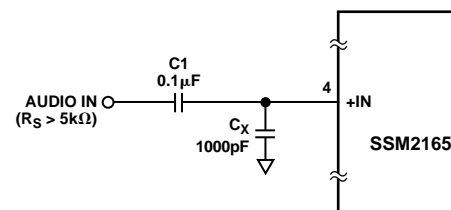

NOTE: ADDITIONAL CIRCUIT DETAILS OMITTED FOR CLARITY.

Figure 7. Circuit Configuration for Use with High Impedance Signal Sources

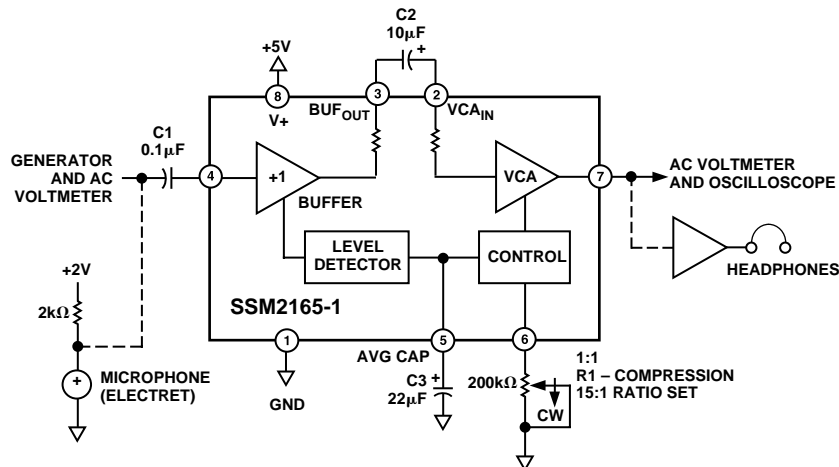

Figure 8. Electret Microphone Preamp Example

### Compression Adjustment—A Practical Example

To illustrate how to set the compression ratio of the SSM2165, we will take a practical example. The SSM2165 will be used interface an electret-type microphone to a post-amplifier, as shown in Figure 8. The signal from the microphone was measured under actual conditions to vary from 2 mV to 30 mV. The post-amplifier requires no more than 350 mV at its input. We will, therefore, choose the SSM2165-1, whose “rotation” point is 40 mV and whose VCA fixed gain is 18 dB ( $\times 8$ ), thus giving 320 mV at limiting. From prior listening experience, we will use a 2:1 compression ratio. The noise gate threshold of the SSM2165-1 will operate when the input signal falls below 500  $\mu$ V. These objectives are summarized in Table II. The transfer characteristic we will implement is illustrated in Figure 10.

Table II. Objective Specification of Example

Input Range	2 mV–30 mV
Output Range	To 350 mV
Limiting Level	320 mV
Compression	2:1
Gain	18 dB
Noise Gate	500 $\mu$ V

### Test Equipment Setup

The recommended equipment and configuration is shown in Figure 9. A low noise audio generator with a smooth output adjustment range of 100  $\mu$ V to 25 mV is a suitable signal source. The output voltmeter should go up to 2 V. The oscilloscope is used to verify that the output is sinusoidal, that no clipping is occurring in the buffer, and to observe the limiting and noise gating “knees.”

### Breadboard Considerations

When building a breadboard, keep the leads to Pins 2 and 3 as short as possible. Use a central analog ground and decouple power supply connections adequately.

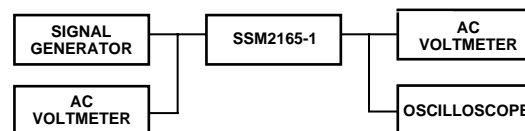

Figure 9. Test Equipment Setup

#### STEP 1. Initialize Potentiometer

With power off, preset R1—Compression Ratio potentiometer to zero ohms.

#### STEP 2. Check Setup

With power on, adjust the generator for an input level of 50 mV (–24 dBu), 1 kHz. The output meter should indicate approximately 350 mV (–6.9 dBu). If not, check the setup.

#### STEP 3. Find the Rotation Point

Set the input level to 50 mV (–24 dBu), and observe the output on the oscilloscope. The output will be in the limiting range of operation. Slowly reduce the input signal level until the output level just begins to stop limiting and follows the input down. Increase the input so that the output is 320 mV (–7.7 dBu). This is the knee of the rotation point.

#### STEP 4. Adjust the Compression Ratio

With the input set as in Step 3, note the exact value of the input signal level just below the knee (around 40 mV (–26 dBu)). Next, reduce the input to 1/4 the value noted, (around 10 mV (–38 dBu)), for a change of –12 dB. Next, increase the  $R_{COMP}$  potentiometer resistance so the output is 160 mV (–13.7 dBu) for an output change of –6 dB. You have now set the compression, which is the ratio of input change to output change, in dB, to 2:1.

#### STEP 5. Confirm the Noise Gate Threshold

Set the input to 1 mV, and observe the output on the oscilloscope. A 20 dB pad between generator and input may facilitate this measurement. Reduce the input gradually until the output falls off more rapidly. This point is the noise gate threshold, and should be approximately 500  $\mu$ V (–64 dBu). The noise gate threshold on the SSM2165 is fixed at 500  $\mu$ V, a practical value for many microphones. Should a different noise gate threshold be required, consider using the SSM2166.



**STEP 6. Listen**

At this time the signal generator may be replaced with a properly powered electret microphone and listen to the results through a set of headphones. The microphone's internal FET usually requires around 2 V through a 2 k $\Omega$  resistor; this varies with the manufacturer. Experiment with the compression ratio value and averaging capacitor size. More compression will keep the output steady over a wider range of microphone-to-source distance. Varying the averaging capacitor,  $C_{AVG}$ , changes the rms detector averaging time, and the decay time of the gate. Both compression ratio and decay time are usually determined by critical listening to the intended audio input.

**STEP 7. Record Values**

With the power removed from the test fixture, measure and record the values of the  $R_{COMP}$  and  $C_{AVG}$ .

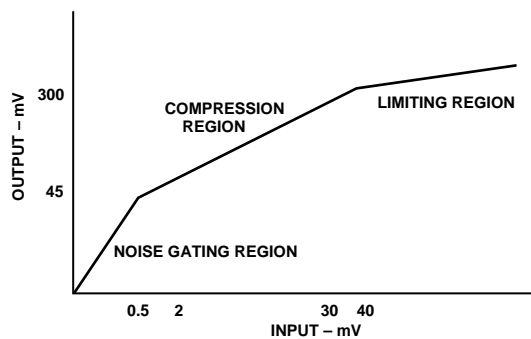

Figure 10. Transfer Characteristic

**SUMMARY**

We have implemented the transfer characteristic of Figure 10. For inputs below the 500  $\mu$ V noise gate threshold, circuit and background noise will be downward expanded (gain-reduced) at a ratio of approximately 1:3. That is, a -1 dB change in the noise will result in -3 dB decrease at the output. Above threshold, the signal will increase at a rate of 1 dB for each 2 dB input increase, until the rotation point is reached at an input of approximately 40 mV. In the limiting region, the compression ratio increases to approximately 15:1. That is, a 15 dB increase in input will produce a 1 dB increase at the output, so there will be little further increase for higher level inputs.

**Other Versions**

The SSM2165 is an 8-lead version of the 14-lead SSM2166 which is recommended for applications requiring more versatility. The SSM2166 allows selection of noise gate threshold and rotation point, and allows the buffer to provide up to 20 dB of gain. Power-down and mute functions are also built in. Customized versions of the SSM2165 are available for large volume users. The wide dynamic range of the SSM2165 makes it useful in many applications other than microphone signal conditioning such as a sustain generator for guitars. For further information, contact your Analog Devices representative.

# SSM2165

## Revision History

Location	Page
Data Sheet changed from REV. A to REV. B.	
Edits to ORDERING GUIDE .....	3



**SSM2165**

C00356-0-1/02(B)

PRINTED IN U.S.A.